

BOX CULVERT

4' TO 12' SPANS
TYPE II - CANTILEVER WALL DESIGN

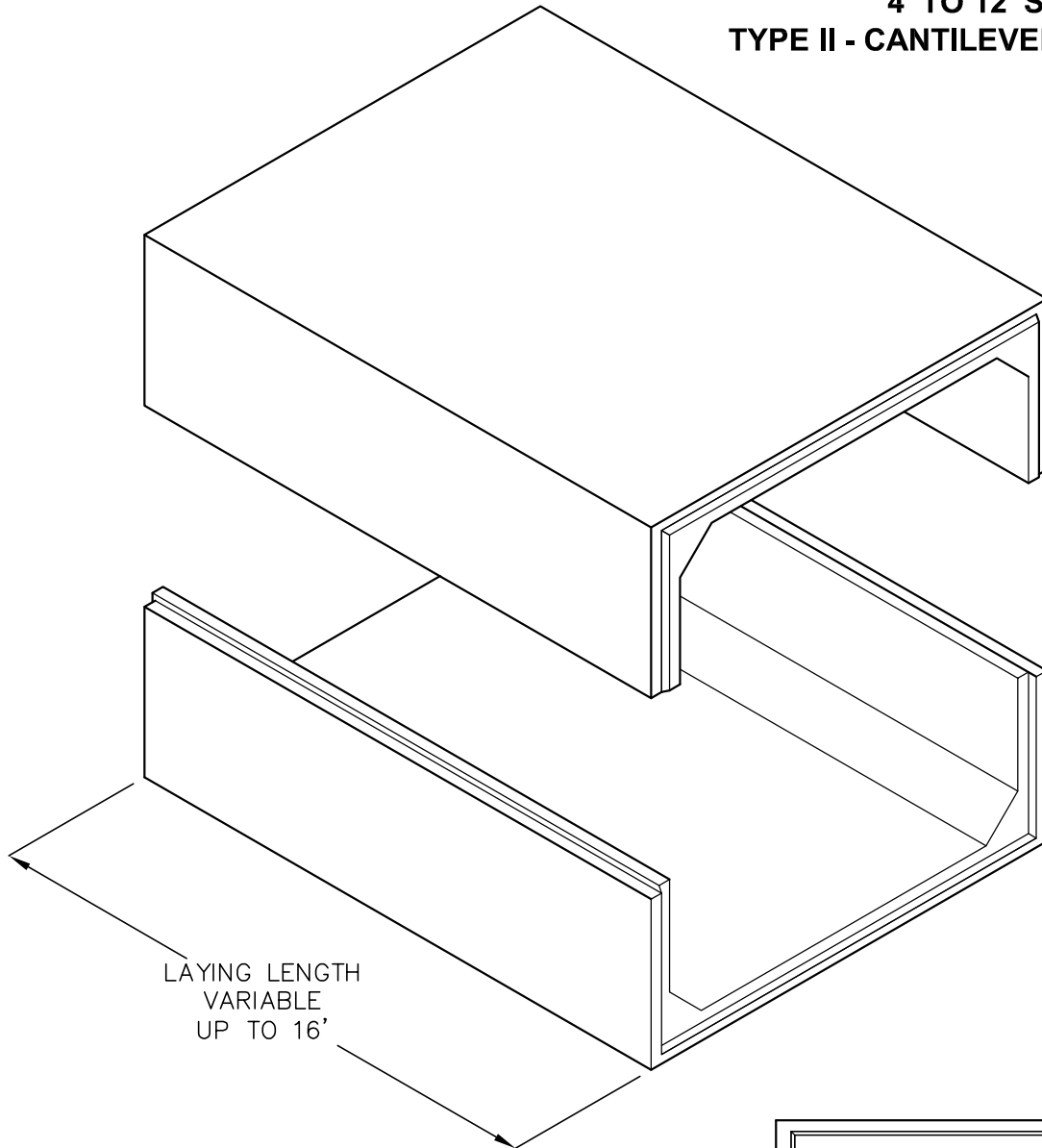

STANDARD DESIGNS MEET AASHTO HL-93 TRAFFIC LOADS IN ACCORDANCE WITH ASTM C1433, ACI 318 AND AASHTO LRFD SPECIFICATIONS.

DESIGNS BASED ON SPECIAL LOADINGS OR DEPTHS OF FILL ARE AVAILABLE ON REQUEST. CUSTOM COMPONENTS CAN BE ENGINEERED WITH OPENINGS, DOWELS AND SKEWS. CUSTOM HEIGHTS ARE AVAILABLE IN 1/2" INCREMENTS.

FOR COMPLETE DESIGN AND PRODUCT INFORMATION CONTACT SPECS.

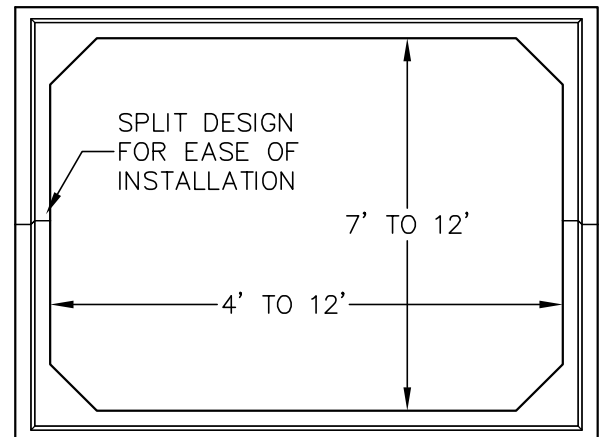

ENDS CAN BE SKEWED TO ALLOW FOR CURVES IN CULVERT RUN -- NO NEED FOR SECONDARY FILLER POUR.